

SMA SERIES

Single Section Wall Mounted Cabinet

Safewell SMA series is supplied flat-packed, which eases access to the installation site while reducing logistics costs and providing greater protection during transit. The most popular model, which was designed to house rack mount equipment for cabling, telecommunications, IT, industrial and home installations.



Highlights

Save Space

1/3 assembled original volume when flat-packed.

Loading Capacity

The loading capacity is over 40KG.

Optional Doors

Toughened glass or vented door is optional, which is at your choice.

Easy Installation

Extremely easy for assembled, it only takes 5 minutes for a skillful person to assemble a whole cabinet.

Big Door-Opening Angle

Turning angle of front door is over 180 degrees.

Features



Structure for easy assembling.



Hanging on the wall with mounting bracket.



120mm*120mm fans can be preinstalled on the top cover. Relevant fan tray suit to all safewell wall mounted cabinets. (Brush panel is optional for cable entry panel.)



Front and rear vertical rails are freely adjustable which simplifies mounting of the device and organization of connecting cables.



Removable side panel simplifies your installation of accessories and monitoring of IT Equipment.



L-shaped spring pin make it fast to install front door to the frame and easily to change door opening direction.

Components of SMA Series Single Section Wall Mounted Cabinet

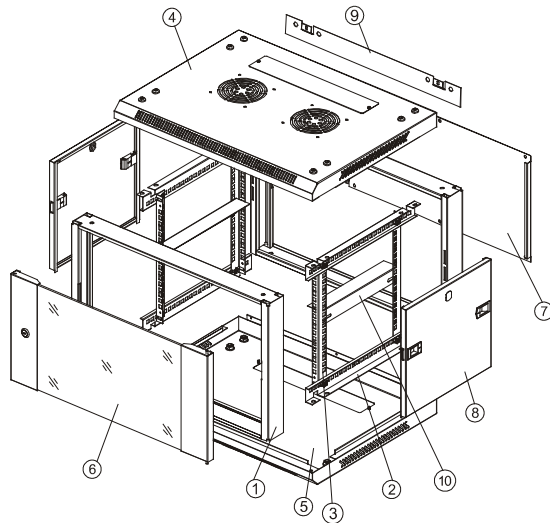

S/N	Name	Quantity
1	Frame	2
2	Horizontal bracket	4
3	Vertical rail	4
4	Top cover	1
5	Bottom panel	1
6	Front door	1
7	Rear panel	1
8	Side panel	2
9	Mounting bracket	1
10	L-shaped bracket	2

Main Dimension

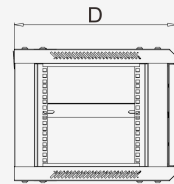

Left View

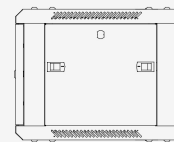

Right View

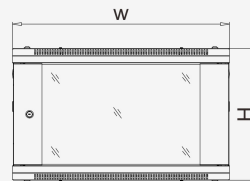

Front View

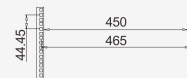

Mounting Dimension

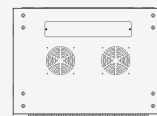

Top View



Rear View

Specifications

Model	Capacity (U)	Dimension W*D*H(mm)	BU Packing Dimension		KD Packing Dimension	
			W*D*H(mm)	Volume (CBM)	W*D*H(mm)	Volume (CBM)
SMA6406	6	600*450*370	615*460*385	0.109	615*465*250	0.071
SMA6506	6	600*500*370	615*510*385	0.121	615*515*250	0.079
SMA6606	6	600*600*370	615*610*385	0.144	615*615*250	0.095
SMA6409	9	600*450*500	615*460*515	0.146	615*520*250	0.080
SMA6509	9	600*500*500	615*510*515	0.162	615*520*250	0.080
SMA6609	9	600*600*500	615*610*515	0.193	615*615*250	0.095
SMA6412	12	600*450*635	615*460*650	0.184	650*615*170	0.068
SMA6512	12	600*500*635	615*510*650	0.204	650*615*170	0.068
SMA6612	12	600*600*635	615*610*650	0.244	650*615*250	0.100
SMA6515	15	600*500*770	615*510*785	0.246	785*615*170	0.082
SMA6615	15	600*600*770	615*610*785	0.294	785*615*250	0.121
SMA6518	18	600*500*905	615*510*920	0.289	920*615*170	0.096
SMA6618	18	600*600*905	615*610*920	0.345	920*615*250	0.141

Note

Package: Build-up(BU) or Knock-down (KD).

Hardware: ≤12U: 12 sets cage nuts; >12U: 24 sets cage nuts.

Color

RAL9005

RAL7035

Material

SPCC Cold Rolled Steel.

Optional Doors-Structure Drawing

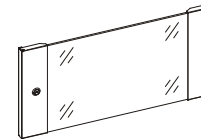

A. Tempered Glass Door
Lock: Small Round Lock

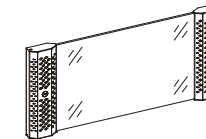

B. Tempered Glass Door, with Vented Holes
Lock: Small Round Lock

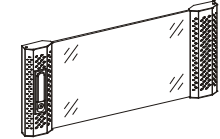

C. Tempered Glass Door, with Vented Holes
Lock: Spring Lock

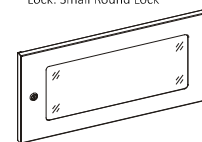

D. Tempered Glass Door
Lock: Small Round Lock

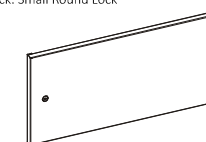

E. Solid Iron Door
Lock: Small Round Lock

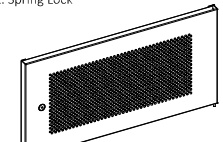

F. Vented Front Door
Lock: Small Round Lock

Knock-down Packaging

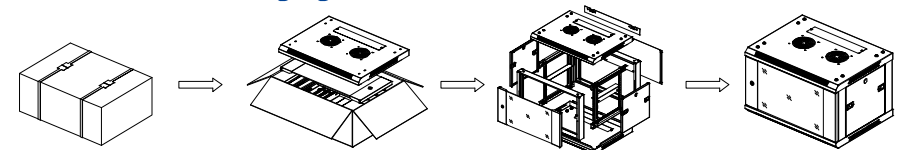

Note: Other regular 19 inch accessories which is used to all racks (shelf, cable manager, fans, blank panel, patch panel and PDU), please refer to page 99 to page 112.